

NBC-M12MSD/10,0-93F/R4AC - Network cable



1192137

<https://www.phoenixcontact.com/us/products/1192137>

Please be informed that the data shown in this PDF document is generated from our online catalog. Please find the complete data in the user documentation. Our general terms of use for downloads are valid.



Network cable, Ethernet CAT5e (100 Mbps), 4-position, shielded, Plug straight M12, coding: D / IP65, on Plug straight RJ45 / IP20, cable length: 10 m

Commercial data

Item number	1192137
Packing unit	1 pc
Minimum order quantity	1 pc
Note	Made to order (non-returnable)
Sales key	BF15
Product key	BF1IHC
GTIN	4063151319519
Weight per piece (including packing)	22.22 g
Weight per piece (excluding packing)	22.22 g
Customs tariff number	85444290
Country of origin	US

1192137

<https://www.phoenixcontact.com/us/products/1192137>

Technical data

Product properties

Product type	Data cable preassembled
Sensor type	Ethernet
Number of positions	4
Application	Standard, U.S. cables
Shielded	yes
Coding	D

Interfaces

Bus system	Ethernet
Signal type/category	Ethernet CAT5e, 100 Mbps

Signaling

Status display	No
Status display present	No

Electrical properties

Nominal voltage U_N	48 V AC
	60 V DC ()
Nominal current I_N	4 A (Plug/socket in accordance with IEC 61076-2-101, cable technical data is to be observed)
	1.5 A (RJ45)
Transmission medium	Copper

Connector

Connection 1

Type	Plug straight M12 / IP65
Coding type	D (Data)
Material	CuSn (Contact)
	Ni/Au (Contact surface)
	PA (Contact carriers)
	TPU, hardly inflammable, self-extinguishing (Grip)
	Zinc die-cast, nickel-plated (Screw connection)
	FKM (Seal)
Degree of protection	IP65

Connection 2

Type	Plug straight RJ45 / IP20
Number of positions	4 (8)
Material	CuSn (Contact)
	Ni/Au (Contact surface)
	PA (Contact carriers)

NBC-M12MSD/10,0-93F/R4AC - Network cable



1192137

<https://www.phoenixcontact.com/us/products/1192137>

	PA (Housing)
Degree of protection	IP20

Cable/line

Cable length	10 m
--------------	------

Highly flexible Ethernet CAT5e [93F]

Dimensional drawing	
UL AWM Style	2463 (80 °C / 600 V)
Number of positions	4
Shielded	yes
Cable type	Highly flexible Ethernet CAT5e [93F]
Conductor structure	2x2xAWG24/7, SF/UTP
Conductor structure signal line	7x 0.20 mm (7x32)
AWG signal line	24
Conductor cross section	2x 2x 0.2 mm ²
Wire diameter incl. insulation	1.2 mm
External cable diameter	6.7 mm ±0.25 mm
Outer sheath, material	TPE
External sheath, color	Teal
Conductor material	Tin-plated Cu litz wires
Material wire insulation	PE
Single wire, color	white/orange-orange, white/green-green
Twisted pairs	2 cores to the pair
Overall twist	2 pairs to the core
Optical shield covering	75 %
Wave impedance	100 Ω ±15 Ω (at 100 MHz)
Cable impedance	100 Ω ±15 Ω (at 1 ... 100 MHz)
Nominal voltage, cable	600 V
Test voltage	2000 V
Max. bending cycles	1000000 20000000 (126 cycles/min. @ 20°C)
Torsion force	360 °/m (1 lb. load)
Torsion cycles	3000000
Torsional frequency	71 (cycles/min)
Ambient temperature (operation)	20 °C
Near end crosstalk attenuation (NEXT)	50 dB (with 100 MHz (IEC 62153-4-9))

NBC-M12MSD/10,0-93F/R4AC - Network cable



1192137

<https://www.phoenixcontact.com/us/products/1192137>

Return attenuation (RL)	20 dB (at 10 MHz (+6LOG))
	26 dB (at 20 MHz)
	26 dB (at 100 MHz (-5LOG))
Flame resistance	VW-1
Other resistance	Resistant to welding splashes (Abrasion and oil resistance)
	UV resistant (CMX outdoor)
Ambient temperature (operation)	-40 °C ... 80 °C (Cable, flexible installation)

Environmental and real-life conditions

Ambient conditions

Degree of protection	IP65
	IP65
Ambient temperature (operation)	-25 °C ... 85 °C (M12 connector)

Standards and regulations

M12

Standard designation	M12 connector
Standards/specifications	IEC 61076-2-101

1192137

<https://www.phoenixcontact.com/us/products/1192137>

Drawings

Schematic diagram



Connector pin assignment plug RJ45

NBC-M12MSD/10,0-93F/R4AC - Network cable



1192137

<https://www.phoenixcontact.com/us/products/1192137>

Dimensional drawing

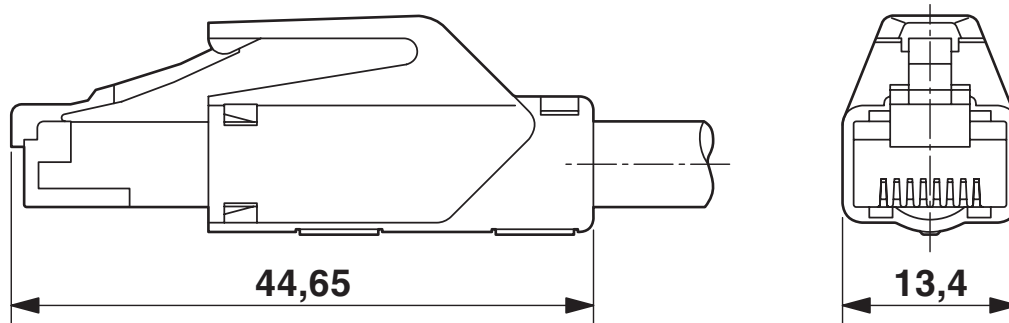

RJ45 connector, IP20

Circuit diagram

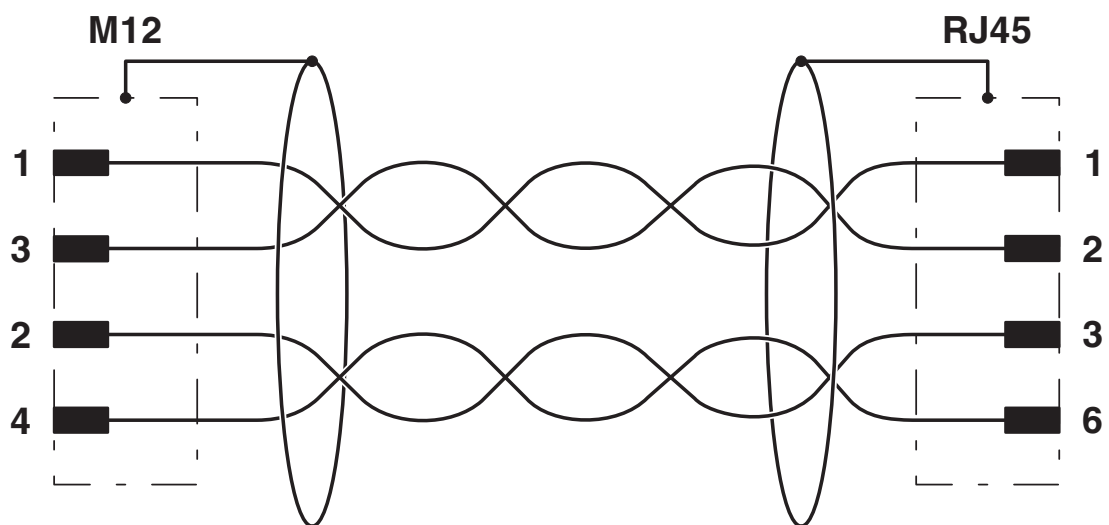

NBC-M12MSD/10,0-93F/R4AC - Network cable

1192137

<https://www.phoenixcontact.com/us/products/1192137>

Dimensional drawing

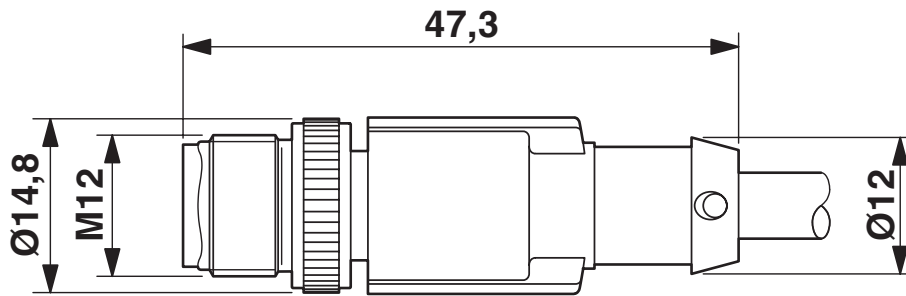

Plug, M12 x 1, straight, shielded

Schematic diagram

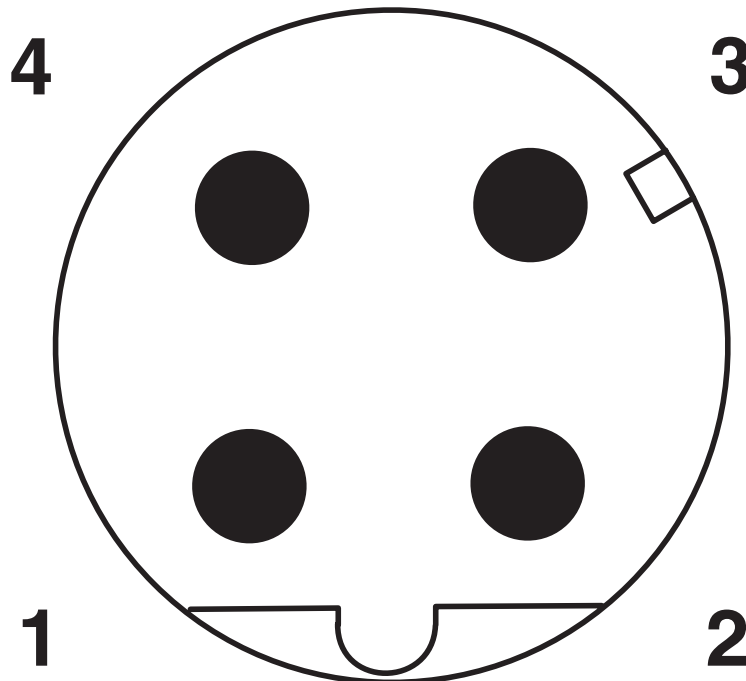

Pin assignment M12 male connector, 4-pos., D-coded, male side

NBC-M12MSD/10,0-93F/R4AC - Network cable





1192137

<https://www.phoenixcontact.com/us/products/1192137>

Approvals

To download certificates, visit the product detail page: <https://www.phoenixcontact.com/us/products/1192137>

 UL Listed Approval ID: File E335024				
	Nominal voltage U_N	Nominal current I_N	Cross section AWG	Cross section mm^2
	60 V	0.5 A	-	-

 cUL Listed Approval ID: File E335024				
	Nominal voltage U_N	Nominal current I_N	Cross section AWG	Cross section mm^2
	60 V	0.5 A	-	-

cULus Listed				
---------------------	--	--	--	--

NBC-M12MSD/10,0-93F/R4AC - Network cable



1192137

<https://www.phoenixcontact.com/us/products/1192137>

Classifications

ECLASS

ECLASS-11.0	27060307
ECLASS-12.0	27060307
ECLASS-13.0	27060307

ETIM

ETIM 8.0	EC001855
----------	----------

UNSPSC

UNSPSC 21.0	26121600
-------------	----------

Phoenix Contact 2024 © - all rights reserved

<https://www.phoenixcontact.com>

Phoenix Contact USA
586 Fulling Mill Road
Middletown, PA 17057, United States
(+717) 944-1300
info@phoenixcon.com